

232 Zamek ćwierćbrotowy

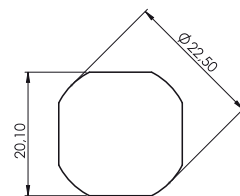

Otwór montażowy

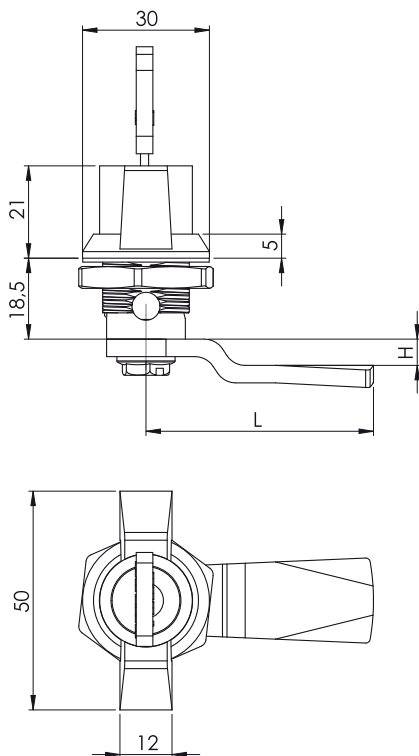

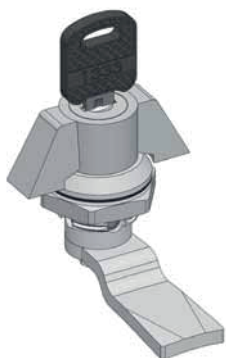
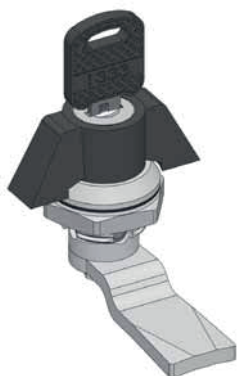

Typ zamka: 232    Kolor: F    Bębenek: CC    Język: CM

Materiał	
Korpus	: Poliamid
Pokrętło	: Poliamid
Nakrętka	: Zamak
Język	: Stal ocynkowana

Kolor (F)		Kod
Chrom		1
Ra1 9005		2

	Klucz jednakowy	01
	Różny kod	02

Języki 2-pkt z ogranicznikiem (CM)												
	Kod	03	020	053	054	055	065					
	H	8	0	0	12	4	0					
	L	49	51	60	54	52	55					

Języki z ogranicznikiem (CM)																
	Kod	01	02	05	06	07	08	09	010	019	043	044	045	046	059	061
	H	14	24	0	16	6	12	0	8	0	0	6	4	10	15	5
	L	48	48	46	46	52	50	54	44	64	44	45	43	48	44	45

H: Wysokość języka    L: Długość języka