

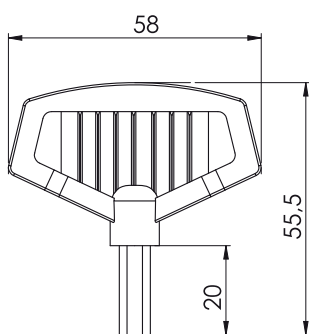

3mm DB

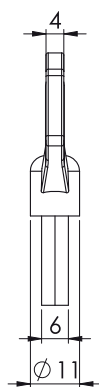

5mm DB

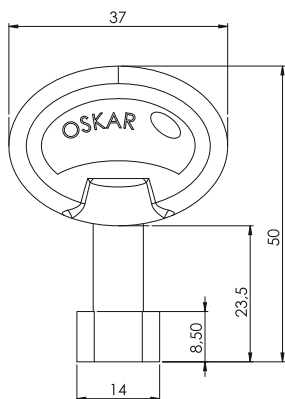

8 mm Trójką

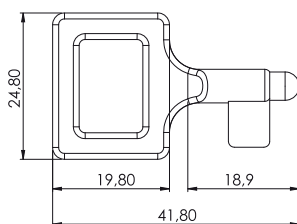
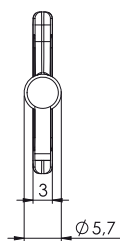
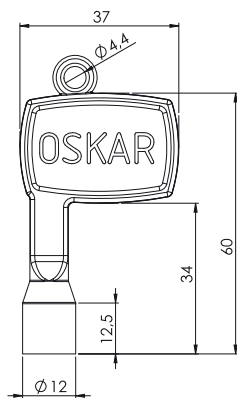

Klucz

203-3



Klucz Sześciokąt

221A



Materiał

Korpus : Poliamid

Klucz

203-4

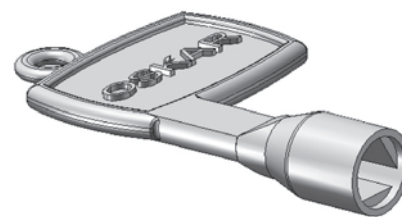

Klucz

211A



Materiał

Korpus : Zamak